

ADATTI PER LA RIGENERAZIONE DELLE FILETTATURE O PER OTTENERE DELLE MASCHIATURE MOLTO RESISTENTI IN MATERIALI TENERI.

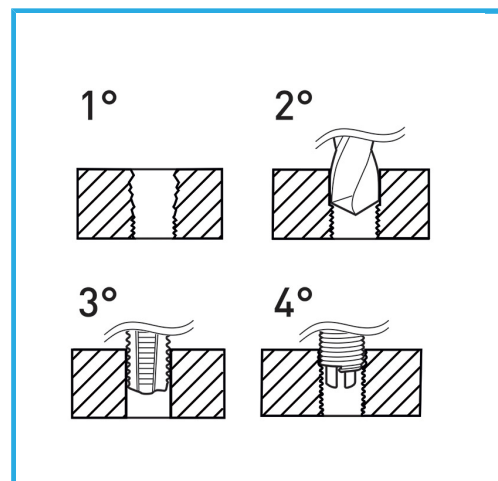

€39,40



Filetto	5/16" x 18
Punta	Ø 8.3 mm
Maschi STI	E011/BSW5/16M
Utensile montaggio	E011/U10
Attrezzo rottura	E011/A11
Inserti filettati	E010/BSW5/16E15
Quantità inserti	20
Dimensioni imballo	170x130x40 h mm
Peso lordo	0,46 kg
Codice EAN	8012667365332



Append.

HSS



INOX