

ADATTI PER LA RIGENERAZIONE DELLE FILETTATURE O PER OTTENERE DELLE MASCHIATURE MOLTO RESISTENTI IN MATERIALI TENERI.

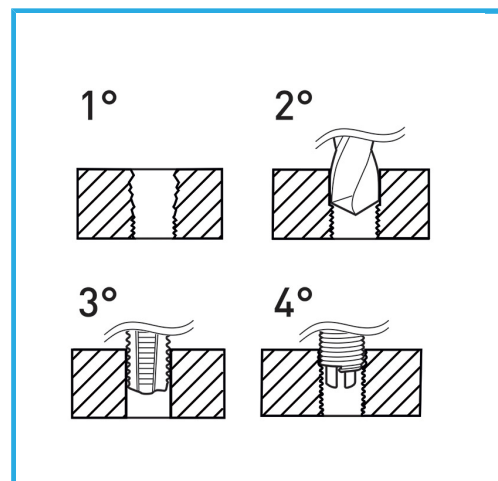

€35,90



Filetto	3/16" x 24
Punta	Ø 5.0 mm
Maschi STI	E011/BSW3/16M
Utensile montaggio	E011/U08
Attrezzo rottura	E011/A8
Inserti filettati	E010/BSW3/16E15
Quantità inserti	20
Dimensioni imballo	170x130x40 h mm
Peso lordo	0,38 kg
Codice EAN	8012667368265



Append.

HSS



INOX