

ADATTI PER LA RIGENERAZIONE DELLE FILETTATURE O PER OTTENERE DELLE MASCHIATURE MOLTO RESISTENTI IN MATERIALI TENERI.

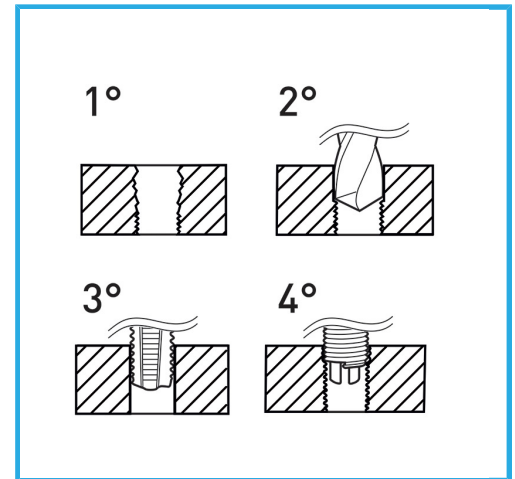

€50,80



Filetto	1/2" x 12
Punta	Ø 13.0 mm
Maschi STI	E011/BSW1/2M
Utensile montaggio	E011/U15
Attrezzo rottura	E011/A15
Inserti filettati	E010/BSW1/2E15
Quantità inserti	10
Dimensioni imballo	170x130x40 h mm
Peso lordo	0,70 kg
Codice EAN	8012667368005



Append.

HSS



INOX