

MOTORE BRUSHLESS, BLOCCO AUTOMATICO DELL'ALBERO,
MANDRINO AUTOSERRANTE IN METALLO SENZA CHIAVE, 21 PUNTI DI
FRIZIONE, SELETTORE...

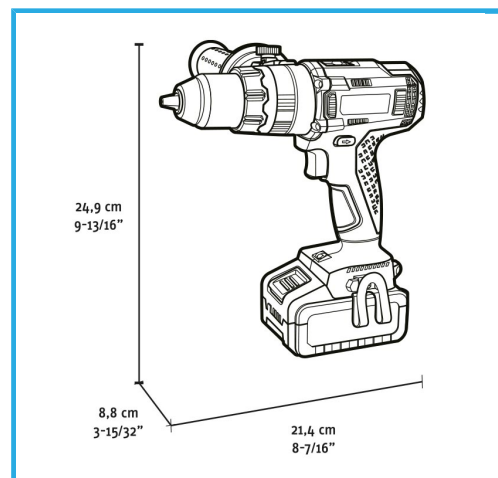

€181,00
~~€259,00~~



Velocità a vuoto	0-550 min-1 / 0-2000 min-1
Percussioni al minuto	0-7500 min-1 / 0-30000 min-1
Serraggio mandrino	1,5 - 13 mm
Coppia max	70 / 75 Nm
Capacità foratura cemento	Max 16 mm
Capacità foratura acciaio	Max 13 mm
Capacità foratura legno	Max 40 mm
Diametro massimo vite	10 mm
Codice EAN	8012667407377
Dimensioni imballo	405 x 330 x 105 h mm
Peso lordo	3,99 kg



Valigetta



Motore
Brushless



Senza
Chiave



Selettore di
Velocità



Velocità
Elettronica



Coppia
Variabile



3 Funzioni

- 1 x 2Ah, 20V

- 2A, 20V