

DIN 2080, CORPO MANDRINO BILANCIATO, CON ASOLA DI ESTRAZIONE PER UTENSILI. EQUILIBRATURA 12.000 RPM.

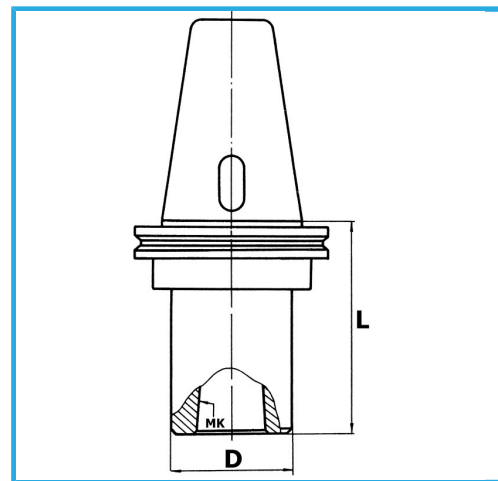

€100,00



ISO	40
CM	2
D	32 mm
L	50 mm
Peso lordo	0,97 kg
Codice EAN	8012667407155



Scatola



Rettificato