

DIN 2080, CORPO MANDRINO BILANCIATO, CON ASOLA DI ESTRAZIONE PER UTENSILI. EQUILIBRATURA 12.000 RPM.

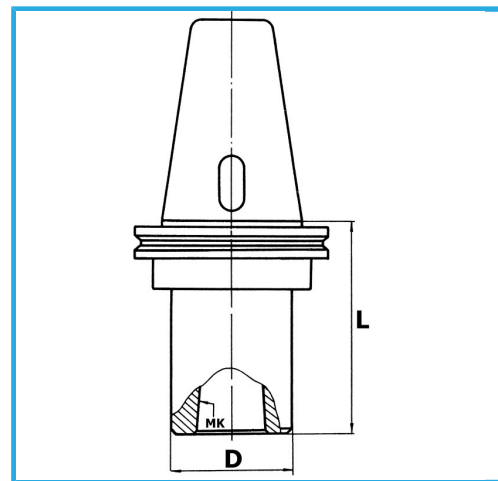

€100,00



ISO	40
CM	3
D	40 mm
L	65 mm
Peso lordo	0,97 kg
Codice EAN	8012667407162



Scatola



Rettificato