

DIN 2080, CORPO MANDRINO BILANCIATO, CON ASOLA DI ESTRAZIONE PER UTENSILI. EQUILIBRATURA 12.000 RPM.

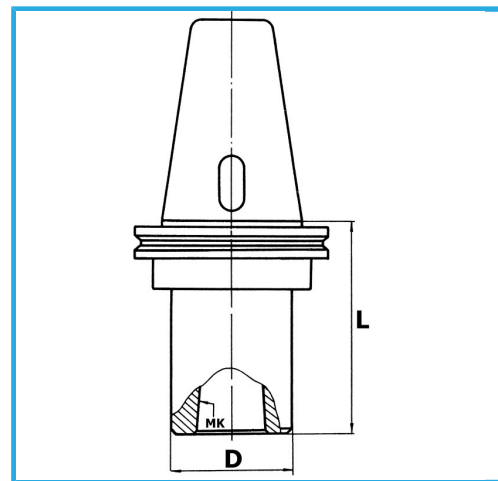

€180,00



ISO	50
CM	4
D	48 mm
L	70 mm
Peso lordo	0,97 kg
Codice EAN	8012667407216



Scatola



Rettificato