

ADATTE PER LAVORI DOVE SONO RICHIESTI PRECISIONE, AFFIDABILITÀ, REPERIBILITÀ E BLOCCAGGIO SICURO. INDICATA PER LAVORI...

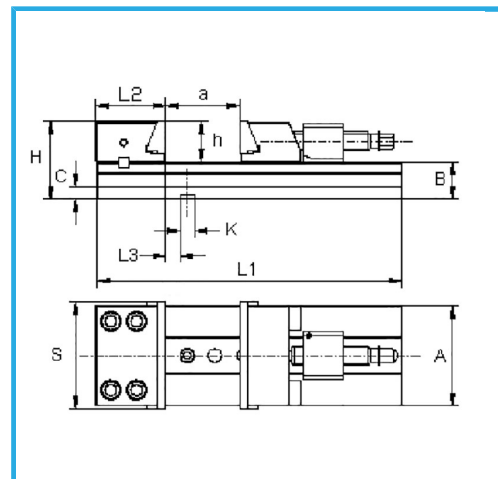

€835,00
~~€1.080,00~~

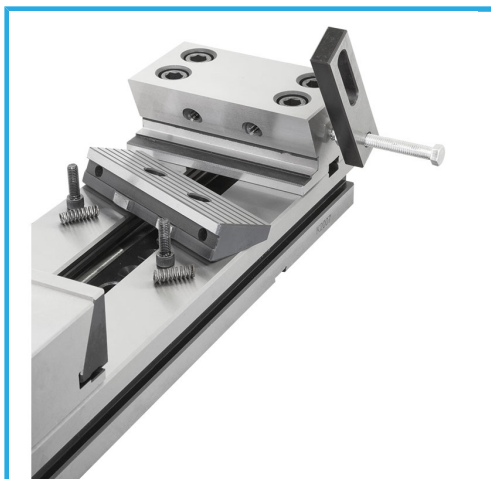
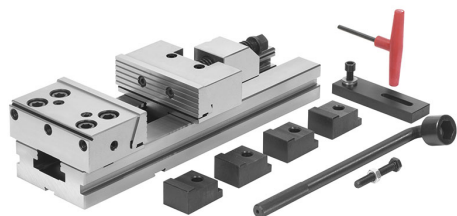

Dimensioni ganascia	150 x 50h mm
S	150 mm
A	125 mm
B	50 mm
C	20 mm
H	100 mm
L1	420 mm
L2	89,4 mm
L3	25,6 mm
h	50 mm
K h7	16 mm
a	200 mm
Peso netto	26 kg
Dimensioni imballo	480x200x180 h mm
Peso lordo	31,00 kg
Codice EAN	8012667245238



Cassa di legno



Temprato



Rettificato



Acciaio