

PERMETTE DI EFFETTUARE UNA LAVORAZIONE SUPERFICIALE SUL PEZZO STAFFATO CON L'UTILIZZO DEL MANDRINO DEL TORNIO COME...

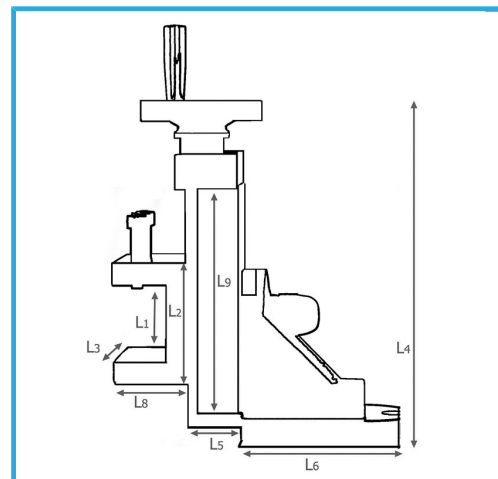

**€162,00**  
~~€215,00~~



L1	52 mm
L2	80 mm
L3	65 mm
L4	220 mm
L5	37 mm
L6	110 mm
L8	46 mm
L9	150 mm
<b>Peso lordo</b>	<b>5,88 kg</b>
<b>Dimensioni imballo</b>	<b>270x250x140 h mm</b>
<b>Codice EAN</b>	<b>8012667232788</b>



Scatola