

TIPO B DOTATO DI VITE PER LA REGOLAZIONE DELL'ALTEZZA E 3 VITI DI SERRAGGIO DELLO STELO.

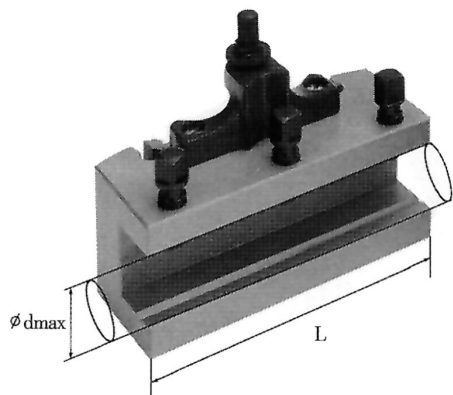

€129,00



L	80 mm
d max	20 mm
Peso lordo	0,62 kg
Dimensioni imballo	95x50x110 h mm
Codice EAN	8012667211516



Scatola