

TIPO D EQUIPADO CON TORNILLO PARA AJUSTE DE ALTURA Y 3  
TORNILLOS DE APRIETE.

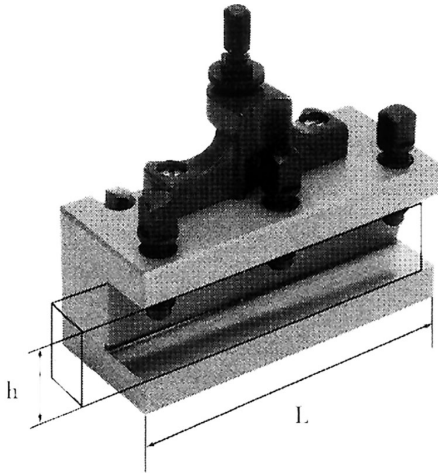

€124,00



<b>L</b>	80 mm
<b>h</b>	16 mm
<b>Peso bruto</b>	0,62 kg
<b>Dimensiones de embalaje</b>	100x105x47 h mm
<b>Codigo de barras</b>	8012667189990



Caja