

TYP D AUSGESTATTET MIT SCHRAUBE ZUR HÖHENVERSTELLUNG
UND 3 KLEMMSCHRAUBEN.

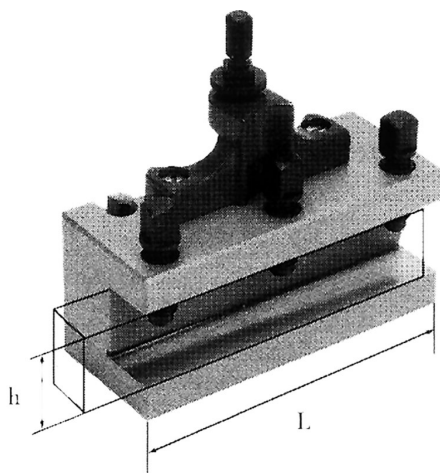

L	150 mm
h	32 mm
Bruttogewicht	3,16 kg
Verpackungsmaße	160x70x155 h mm
EAN-Code	8012667183141



Box