

EQUIPPED WITH MICROMETRIC ADJUSTMENT AND OIL BATH GEARS.

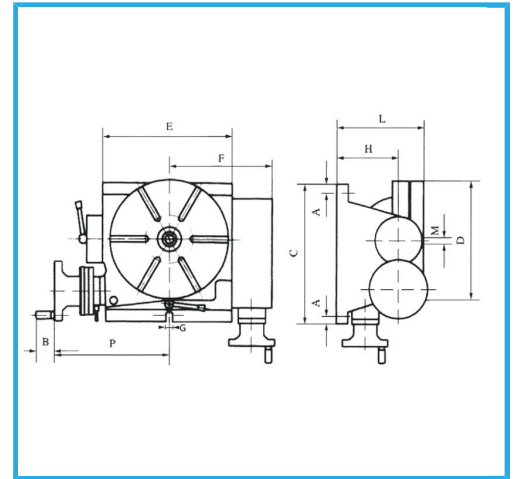

A	14 mm
B	40 mm
C	310 mm
D	250 mm
E	252 mm
F	199 mm
G	14 mm
H	140 mm
L	205 mm
MT	3
Ratio	1:90
Slots	6/12 N° / mm
Hor. max load	200 kg
Ver. max load	100 kg
Net weight	78 kg
Packaging dimensions	540 x 420 x 330 h mm
Gross weight	90,00 kg
EAN Code	8012667003074



Wooden Box