

DOTATA DI REGOLAZIONE MICROMETRICA ED INGRANAGGI A BAGNO
D'OLIO.

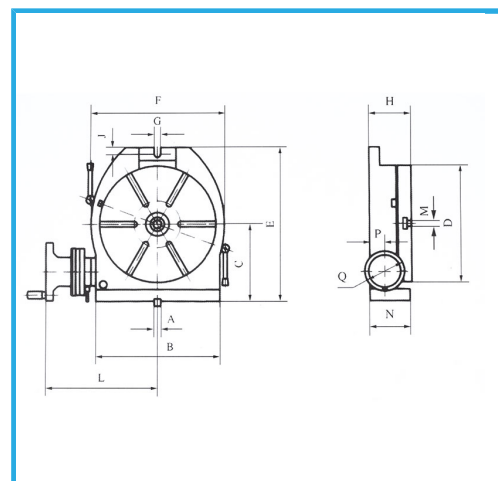

€1.040,00

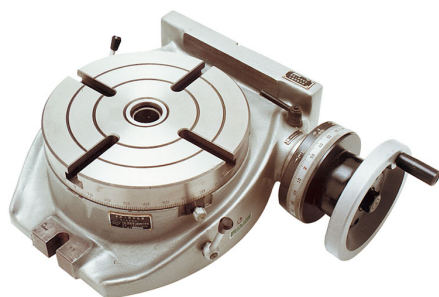

A	14 mm
B	253 mm
C	170 mm
D	250 mm
E	328 mm
F	286 mm
G	14 mm
H	110 mm
J	16 mm
L	241 mm
N	106 mm
P	48 mm
Q	125 mm
CM	4
Rapporto	1:90
Cave	6/12 N° / mm
Portata max orizzontale	200 kg
Portata max verticale	100 kg
Peso netto	44 kg
Dimensioni imballo	505x455x240 h mm
Peso lordo	54,50 kg
Codice EAN	8012667003104



Cassa di
legno