

DOTATA DI REGOLAZIONE MICROMETRICA ED INGRANAGGI A BAGNO
D'OLIO.

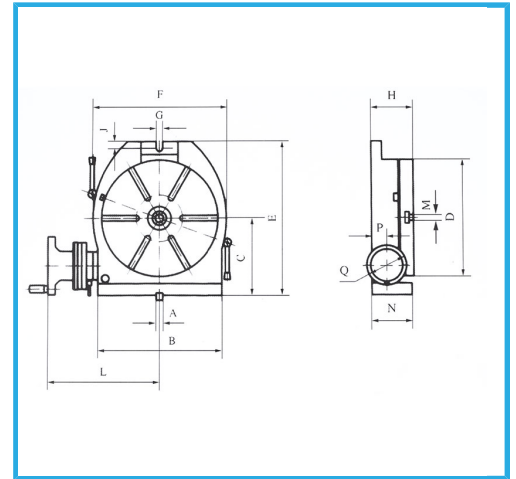

€2.340,00

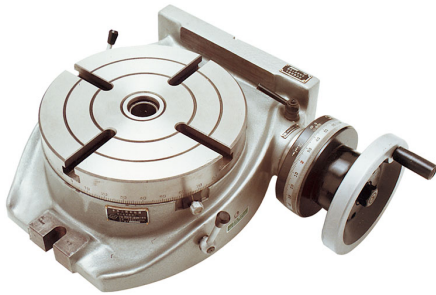

A	18 mm
B	400 mm
C	260 mm
D	400 mm
E	525 mm
F	450 mm
G	18 mm
H	150 mm
J	16 mm
L	337 mm
N	145 mm
P	70 mm
Q	160 mm
CM	4
Rapporto	1:90
Cave	6/14 N° / mm
Portata max orizzontale	300 kg
Portata max verticale	150 kg
Peso netto	174 kg
Dimensioni imballo	750x685x275 h mm
Peso lordo	174,00 kg
Codice EAN	8012667180294



Cassa di
legno