

DIN 69871/A, CORPO MANDRINO BILANCIATO, PER FRESE
CILINDRICHE FRONTALI SECONDO NORMA DIN 481, PER FRESE CON
SCANALATURA...

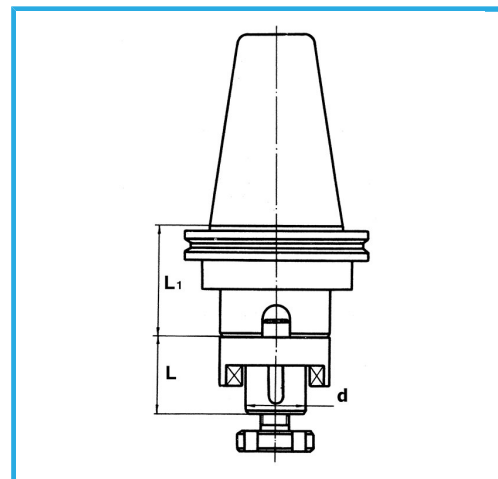

€119,00



ISO	40
d-h6	16 mm
L	27 mm
L1	35 mm
Equilibratura rpm	12000
Peso lordo	1,18 kg
Codice EAN	8012667008031



Scatola

18Ni
CrMo5



Rettificato