

DIN 69871/A, CORPO MANDRINO BILANCIATO, PER FRESE
CILINDRICHE FRONTALI SECONDO NORMA DIN 481, PER FRESE CON
SCANALATURA...

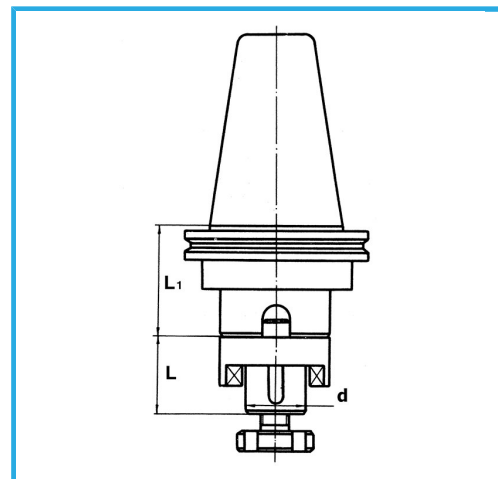

€176,00



ISO	50
d-h6	32 mm
L	38 mm
L1	40 mm
Equilibratura rpm	12000
Peso lordo	4,94 kg
Codice EAN	8012667008154



Scatola

18Ni
CrMo5



Rettificato