

DIN 69871/A, CORPO MANDRINO BILANCIATO, PER FRESE (WELDON)
SECONDO NORMA DIN 1835 B E DIN 6535 HB. FORNITO CON VITE DI...

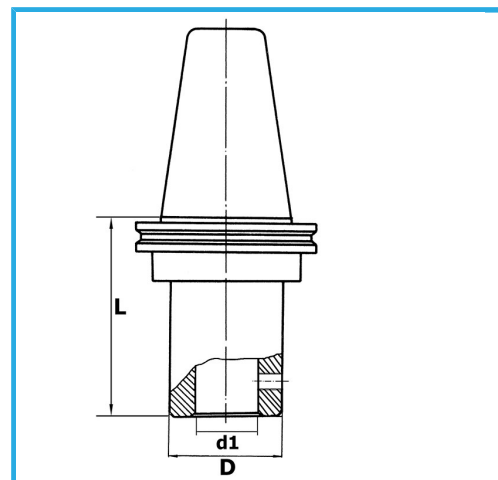

€140,00



| | |
|------------|---------------|
| ISO | 50 |
| d1 - h6 | 25 mm |
| D | 65 mm |
| L | 100 mm |
| Peso lordo | 3,87 kg |
| Codice EAN | 8012667193218 |



Scatola



Rettificato

18Ni
CrMo5