

MAS-403 BT, CORPO MANDRINO BILANCIATO, PER FRESE  
CILINDRICHE FRONTALI SECONDO NORMA DIN 481, PER FRESE CON  
SCANALATURA...

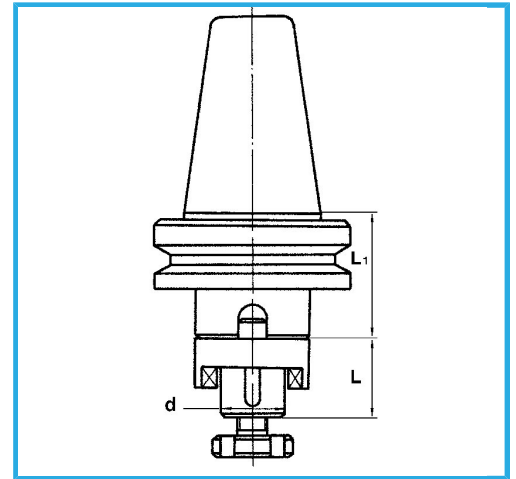

€189,00



BT	50
d - h6	40 mm
L	41 mm
L1	40 mm
Peso lordo	4,18 kg
Codice EAN	8012667008611



Scatola



Temprato



Rettificato



18Ni  
CrMo5