

DIN 2080, CORPO MANDRINO BILANCIATO, PER FRESE CILINDRICHE FRONTALI SECONDO NORMA DIN 481, PER FRESE CON SCANALATURA...

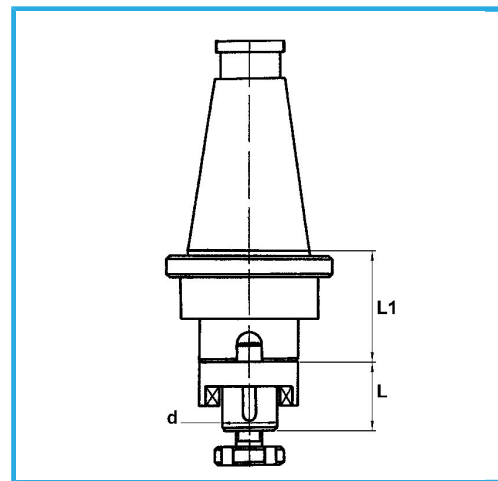

€158,00



ISO	50
d - h6	16 mm
L	27 mm
L1	35 mm
Peso lordo	4,16 kg
Codice EAN	8012667008321



Scatola



Rettificato

18Ni  
CrMo5