

DIN 2080, CORPO MANDRINO BILANCIATO, PER FRESE CILINDRICHE FRONTALI SECONDO NORMA DIN 481, PER FRESE CON SCANALATURA...

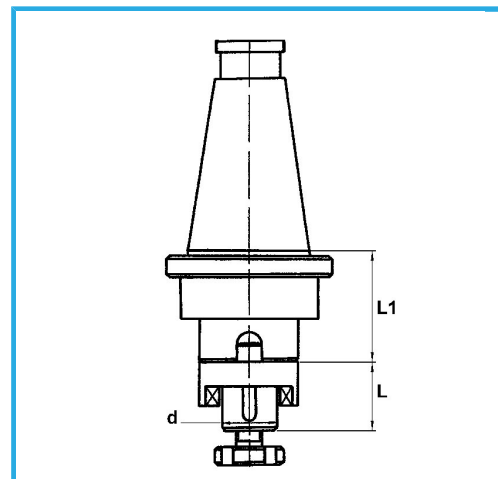

€131,00



ISO	40
d - h6	22 mm
L	31 mm
L1	39 mm
Peso lordo	1,53 kg
Dimensioni imballo	200x70x70 h mm
Codice EAN	8012667008291



Scatola



Rettificato

18Ni
CrMo5