

DIN 2080, CORPO MANDRINO BILANCIATO, PER FRESE (WELDON)
SECONDO NORMA DIN 1835 B E DIN 6535 HB. FORNITO CON VITE DI
SERRAGGIO....

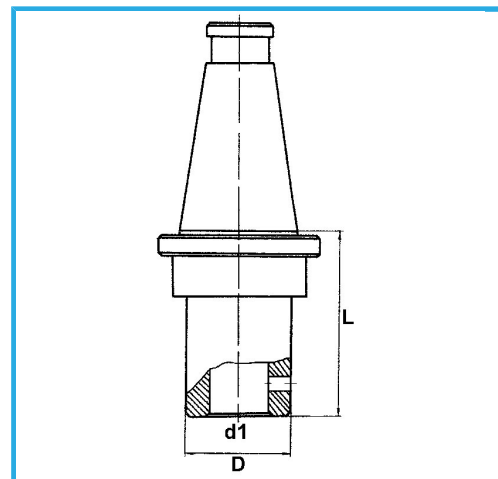

€140,00



ISO	50
d1 - h6	10 mm
D	35 mm
L	50 mm
Peso lordo	2,90 kg
Codice EAN	8012667193102



Scatola



Rettificato

18Ni
CrMo5