

DIN 2080, CORPO MANDRINO BILANCIATO, PER FRESE (WELDON)  
SECONDO NORMA DIN 1835 B E DIN 6535 HB. FORNITO CON VITE DI  
SERRAGGIO....

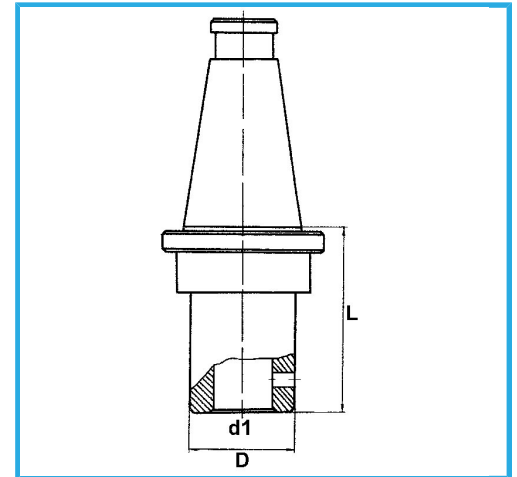

€140,00



ISO	50
d1 - h6	12 mm
D	42 mm
L	50 mm
Peso lordo	3,06 kg
Codice EAN	8012667193133



Scatola



Rettificato

18Ni  
CrMo5