

DIN 2080, CORPO MANDRINO BILANCIATO, PER FRESE (WELDON)
SECONDO NORMA DIN 1835 B E DIN 6535 HB. FORNITO CON VITE DI
SERRAGGIO....

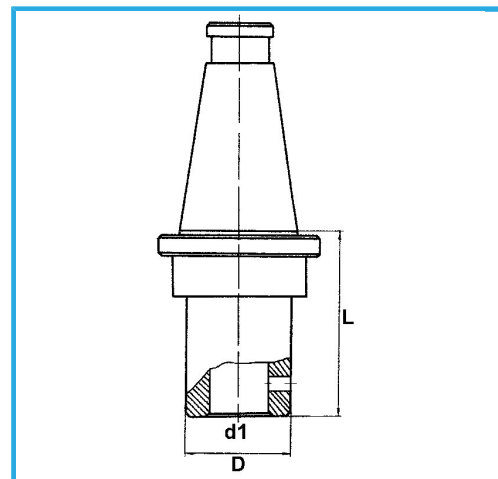

€140,00



| | |
|------------|---------------|
| ISO | 50 |
| d1 - h6 | 16 mm |
| D | 48 mm |
| L | 50 mm |
| Peso lordo | 4,06 kg |
| Codice EAN | 8012667193188 |



Scatola



Rettificato

18Ni
CrMo5