

COMPOSTO DALL'UTENSILE PER FILETTATURA ESTERNA (1 PZ), VITE DI RICAMBIO M3.5 X 12MM (1 PZ), CHIAVE ESAGONALE 2,5MM (1 PZ),...

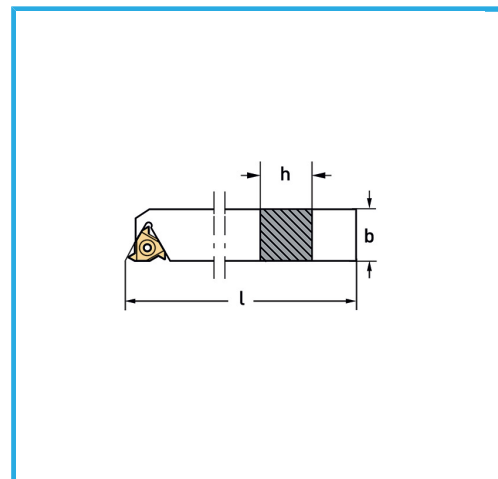

€150,00
~~€188,00~~

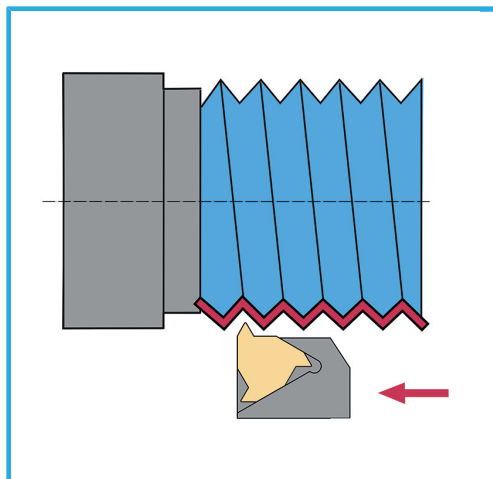

Utensili per esterno

Inserto

Chiave torx

Vite

b

l

h

Peso lordo

Dimensioni imballo

Codice EAN

SER20

16ER...

T15

M3,5 x 12 mm

20 mm

20 mm

125 mm

0,82 kg

240x180x50 h mm

8012667252656



Satinata



Nichelata



Esterna



15 Pcs



Valigetta