

€10,40

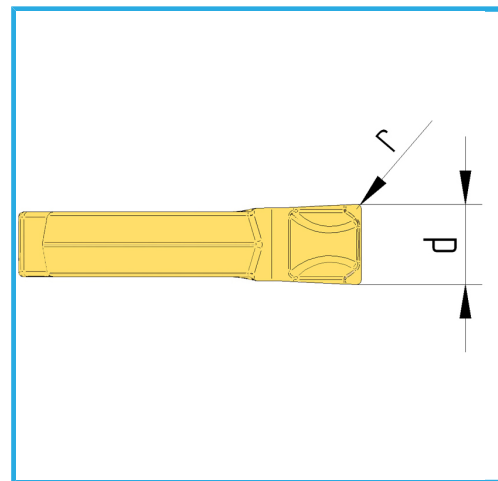

d	4.10 mm
r	0.20 mm
Pack	10
Peso lordo	0,01 kg
Codice EAN	8012667192303

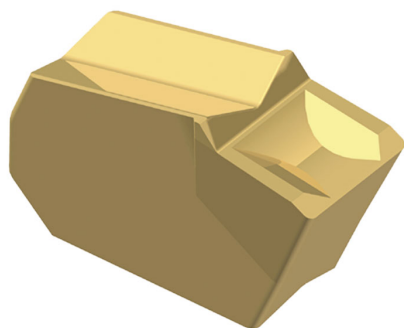

Scatola



-