

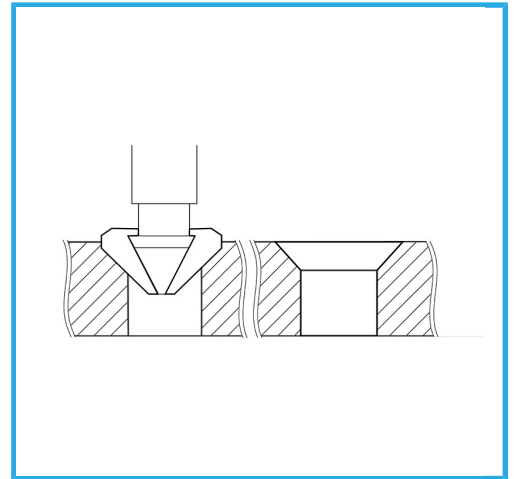







CON SPOGLIE RETTIFICATE E SCANALATURE RICAVATE DAL PIENO,  
PER ESEGUIRE SVASATURE CONICHE SENZA VIBRAZIONI.



**€81,10**  
~~€97,80~~



**Ø max** 6 - 8 - 10 - 12,4 - 16,5 - 20,5 mm  
**Peso lordo** 0,48 kg  
**Dimensioni imballo** 145x105x45 h mm  
**Codice EAN** 8012667183257

	Append.		90°
	Esterna		6 Pcs
	335C		HSS -
	TIN		-