

ADATTI PER LA RIGENERAZIONE DELLE FILETTATURE O PER OTTENERE DELLE MASCHIATURE MOLTO RESISTENTI IN MATERIALI TENERI.

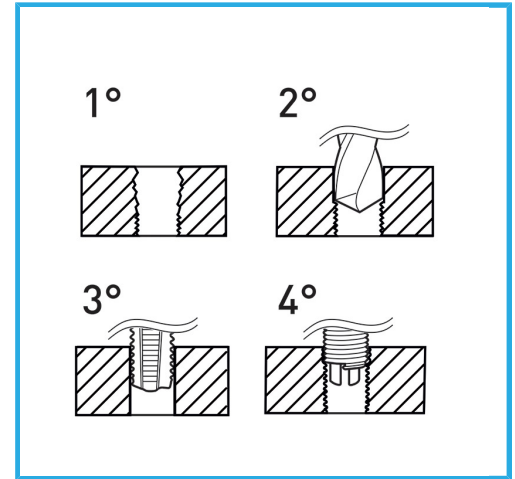

€41,10



Filetto inserto	M10
Punta	10,4 mm
Maschio	x M10
Manico	2
Peso lordo	0,58 kg
Dimensioni imballo	160x110x30 h mm
Codice EAN	8012667249960



Append.

HSS



INOX