

# ART. 0855/T30

TWO WAY TORX AND TAMPERED KEY WITH ANATOMIC PLASTIC HANDLE

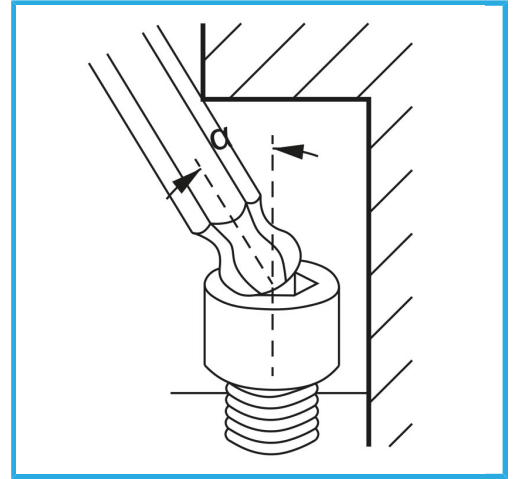

Size	T30
Length	150 mm
Gross weight	0,08 kg
Packaging dimensions	280x70x25 h mm
EAN Code	8012667187033



Hangable



Chromed



-



-