

ART. 0855/T30
CHIAVI TORX CON MANICO ANATOMICO IN PLASTICA

FERVI

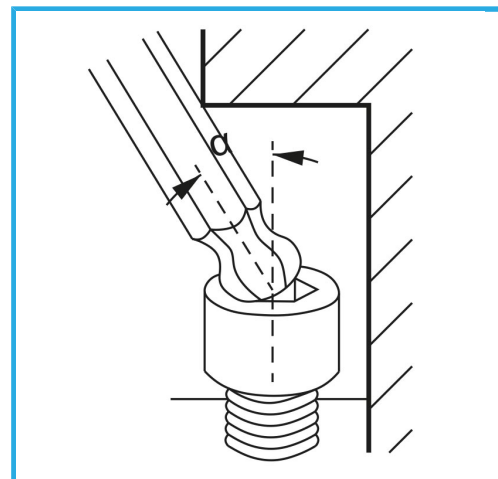

€4,13



Misura	T30
Lunghezza	150 mm
Peso lordo	0,08 kg
Dimensioni imballo	280x70x25 h mm
Codice EAN	8012667187033



Append.



Cromata



-



Mo-V

-