

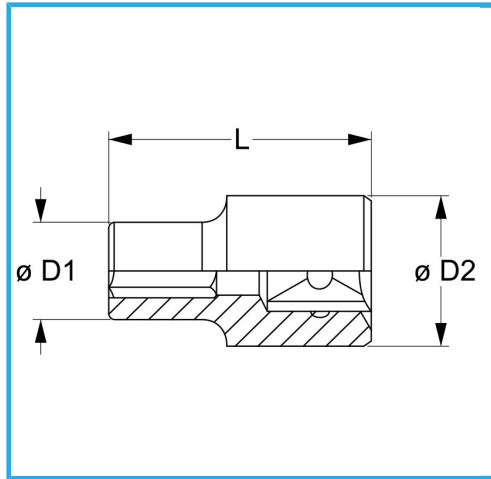





€7,90



Misura	19 mm
D1	30 mm
D2	36 mm
Lunghezza	50 mm
Peso lordo	0,22 kg
Dimensioni imballo	59 x 36 x 124 h mm
Codice EAN	8012667280635

	Append.		Cromata
	3/4"		3124
	-		-