

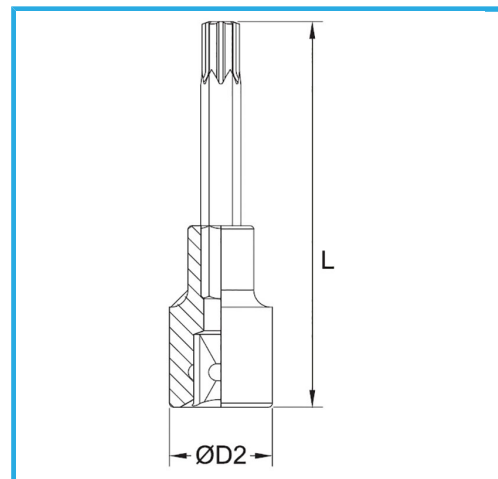

€9,50



Misura	T50
D2	22 mm
Lunghezza	100 mm
Peso lordo	0,09 kg
Codice EAN	8012667282547



Append.



-



Cr-V

-



Cromata



1/2"