

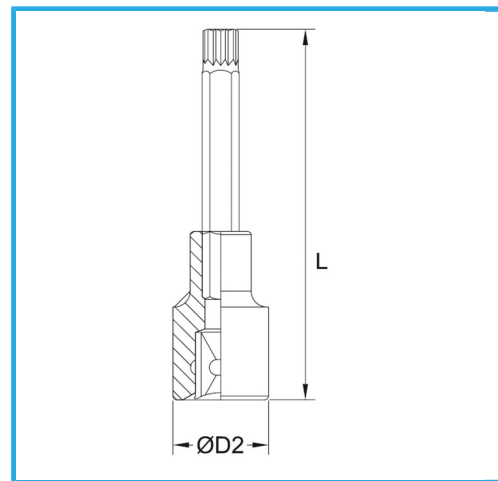

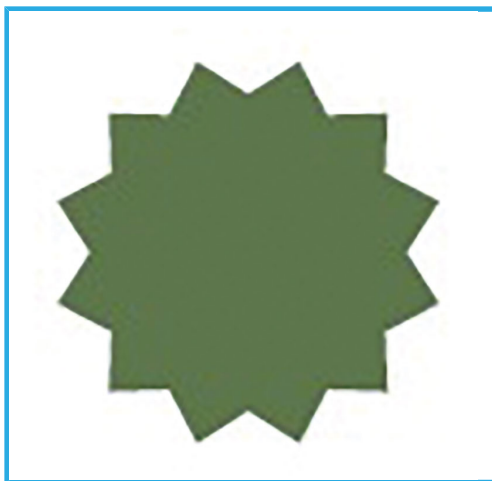





€10,80



Misura	M 9
D2	22 mm
Lunghezza	100 mm
Peso lordo	0,10 kg
Codice EAN	8012667282813

	Append.		-
	-		Cromata
	1/2"		